

## ICE5N65 N-Channel Enhancement Mode MOSFET

### Features

- Low  $r_{DS(on)}$
- Ultra Low Gate Charge
- High  $dv/dt$  capability
- High Unclamped Inductive Switching (UIS) capability
- High peak current capability
- Increased transconductance performance
- Optimized design for high performance power systems

Product Summary			
$I_D$	$T_c=25^\circ\text{C}$	5A	Max
$V_{(BR)DSS}$	$I_D=250\mu\text{A}$	650V	Min
$r_{DS(on)}$	$V_{GS}=10\text{V}$	$0.75\Omega$	Typ
$Q_g$	$V_{DS}=480\text{V}$	22nC	Typ

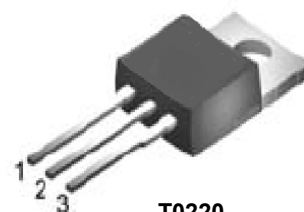
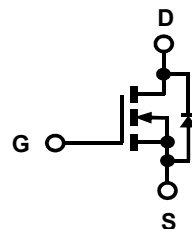

T0220

Standard Metal  
Heatsink

1=Gate, 2=Drain,  
3=Source.

ICEMOS AND ITS SISTER COMPANY 3D SEMI OWN THE FUNDAMENTAL PATENTS FOR SUPERJUNCTION MOSFETS. THE MAJORITY OF THESE PATENTS HAVE 17 to 20 YEARS OF REMAINING LIFE. THIS PORTFOLIO HAS GRANTED PATENTS ISSUED IN USA, CHINA, KOREA, JAPAN, TAIWAN & EUROPE.

**Maximum ratings**<sup>a</sup> at  $T_j=25^\circ\text{C}$ , unless otherwise specified

Parameter	Symbol	Conditions	Value	Unit
Continuous drain current	$I_D$	$T_c=25^\circ\text{C}$ $T_c=100^\circ\text{C}$	5 3.1	A
Pulsed drain current	$I_{D, pulse}$	$T_c=25^\circ\text{C}$	15	A
Avalanche energy, single pulse	$E_{AS}$	$I_D=2.5\text{A}$	80	mJ
Avalanche current, repetitive	$I_{AR}$	limited by $T_j\text{max}$	2	A
MOSFET $dv/dt$ ruggedness	$dv/dt$	$V_{DS}=480\text{V}$ , $I_D=5\text{A}$ , $T_j=125^\circ\text{C}$	50	V/ns
Gate source voltage	$V_{GS}$	Static	$\pm 20$	V
		AC ( $f>1\text{Hz}$ )	$\pm 30$	
Power dissipation	$P_{tot}$	$T_c=25^\circ\text{C}$	65	W
Operating and storage temperature	$T_j, T_{stg}$		-55 to +150	$^\circ\text{C}$
Mounting torque <sup>b</sup>		M 3 & 3.5 screws	60	Ncm

<sup>a</sup> Preliminary Data Sheet – Specifications subject to change

<sup>b</sup> When mounted on 1inch square 2oz copper clad FR-4

Parameter	Symbol	Conditions	Values			Unit
			Min	Typ	Max	

### Thermal characteristics

Thermal resistance, junction-case	$R_{thJC}$		-	-	1.9	°C/W
Thermal resistance, junction-ambient	$R_{thJA}$	leaded	-	-	68	
Soldering temperature, wave soldering only allowed at leads	$T_{sold}$	1.6mm (0.063in.) from case for 10 s	-	-	260	°C

### Electrical characteristics<sup>a</sup> at $T_j=25^\circ\text{C}$ , unless otherwise specified

#### Static characteristics

Drain-source breakdown voltage	$V_{(BR)DSS}$	$V_{GS}=0\text{ V}, I_D=250\mu\text{A}$	650	690	-	V
Gate threshold voltage	$V_{GS(th)}$	$V_{DS}=V_{GS}, I_D=250\mu\text{A}$	2.1	3.1	3.9	
Zero gate voltage drain current	$I_{DSS}$	$V_{DS}=650\text{V}, V_{GS}=0\text{V}, T_j=25^\circ\text{C}$	-	0.04	1	$\mu\text{A}$
		$V_{DS}=650\text{V}, V_{GS}=0\text{V}, T_j=150^\circ\text{C}$	-	14	-	
Gate source leakage current	$I_{GSS}$	$V_{GS}=\pm 20\text{ V}, V_{DS}=0\text{V}$	-	-	100	nA
Drain-source on-state resistance	$r_{DS(on)}$	$V_{GS}=10\text{V}, I_D=2.5\text{A}, T_j=25^\circ\text{C}$	-	0.75	0.95	$\Omega$
		$V_{GS}=10\text{V}, I_D=2.5\text{A}, T_j=150^\circ\text{C}$	-	2.2	-	
Gate resistance	$R_G$	$f=1\text{ MHz}, \text{open drain}$	-	3.8	-	$\Omega$

#### Dynamic characteristics

Input capacitance	$C_{iss}$	$V_{GS}=0\text{ V}, V_{DS}=25\text{ V}, f=1\text{ MHz}$	-	625	-	pF
Output capacitance	$C_{oss}$		-	59	-	
Reverse transfer capacitance	$C_{rss}$		-	1.2	-	
Transconductance	$g_{fs}$	$V_{DS}>2*I_D*R_{DS}, I_D=2.5\text{A}$	-	4	-	S
Turn-on delay time	$t_{d(on)}$	$V_{DS}=480\text{V}, V_{GS}=10\text{V}, I_D=5\text{A}, R_G=4\Omega \text{ (External)}$	-	22	-	ns
Rise time	$t_r$		-	23	-	
Turn-off delay time	$t_{d(off)}$		-	52	-	
Fall time	$t_f$		-	18	-	

Parameter	Symbol	Conditions	Values			Unit
			Min	Typ	Max	

### Gate charge characteristics

Gate to source charge	$Q_{gs}$	$V_{DS}=480\text{ V}, I_D=5\text{ A},$ $V_{GS}=0\text{ to }10\text{ V}$	-	3.6	-	nC
Gate to drain charge	$Q_{gd}$		-	7.9	-	
Gate charge total	$Q_g$		-	22	-	
Gate plateau voltage	$V_{plateau}$		-	5.1	-	V

### Reverse Diode

Continuous forward current	$I_S$	$V_{GS}=0\text{ V}$	-	-	5	A
Diode forward voltage	$V_{SD}$	$V_{GS}=0\text{ V}, I_S=I_F$	-	0.8	1.2	V
Reverse recovery time	$t_{rr}$	$V_{RR}=100\text{ V}, I_S=I_F,$ $d_{iF}/d_t=100\text{ A}/\mu\text{S}$	-	240	-	ns
Reverse recovery charge	$Q_{rr}$		-	2.5	-	$\mu\text{C}$
Peak reverse recovery current	$I_{rm}$		-	20	-	A

Output Characteristics

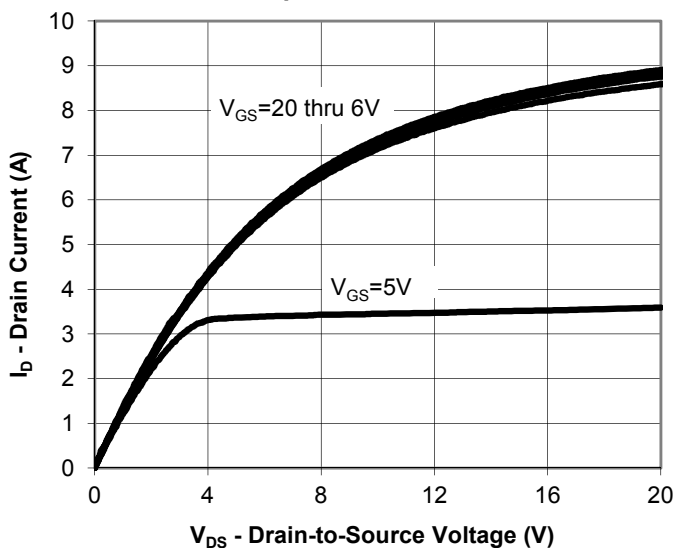

Transfer Characteristics

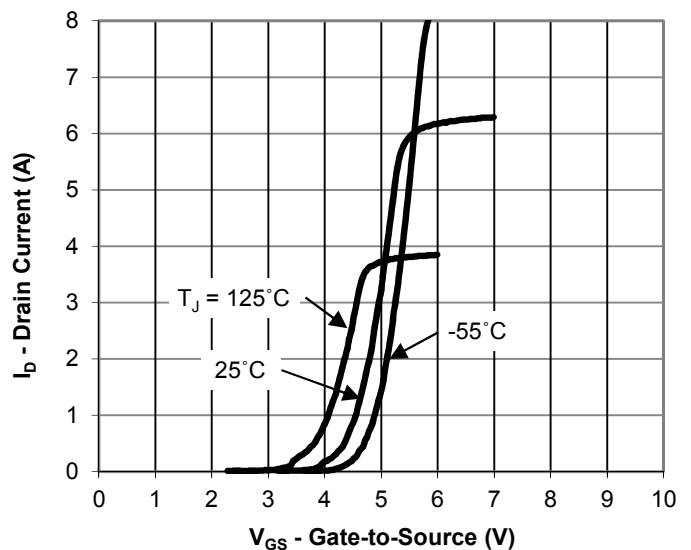

**Drain-Source On-State Resistance vs. Drain Current**

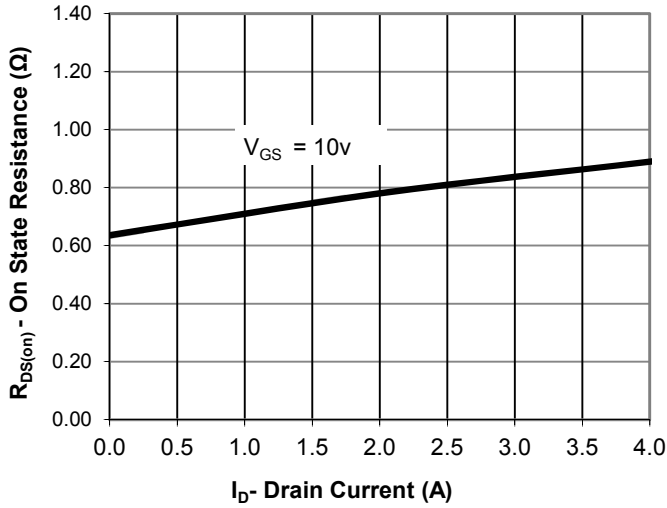

**Drain-Source On-State Resistance vs. Gate-to-Source Voltage**

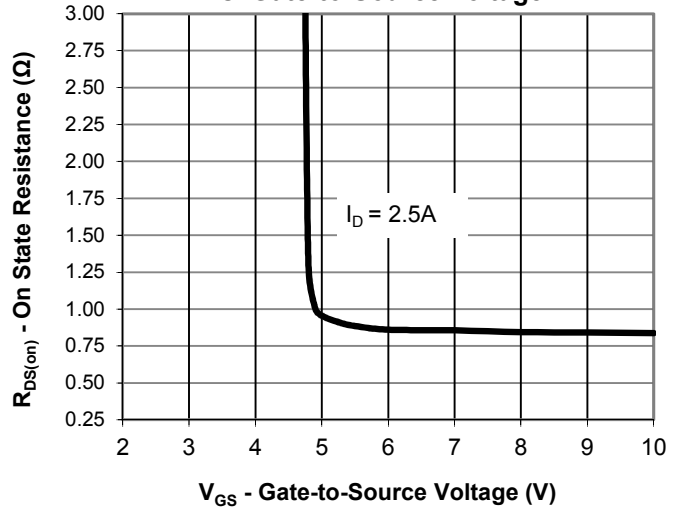

**Drain-Source On State Resistance vs. Junction Temperature**

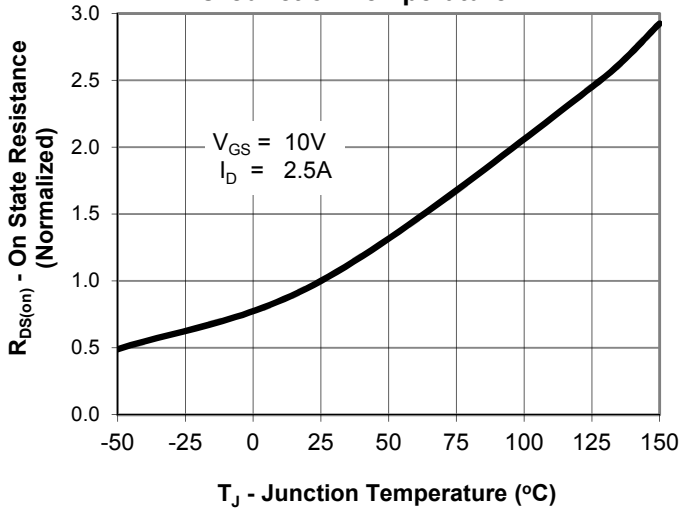

**Gate Threshold Voltage vs. Junction Temperature**

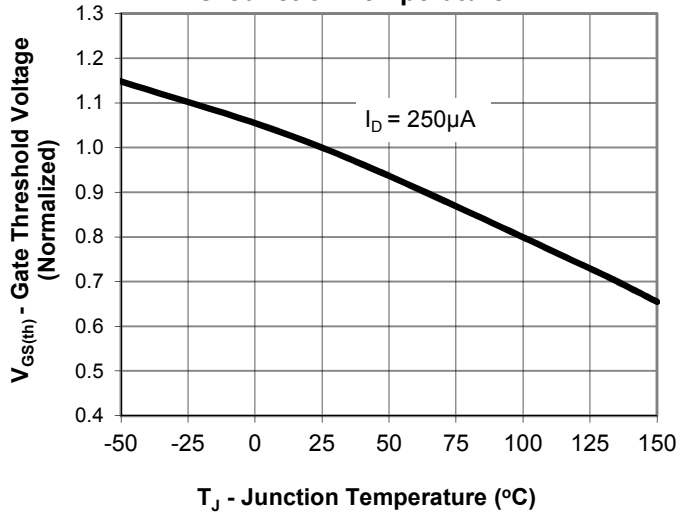

**Gate Charge**

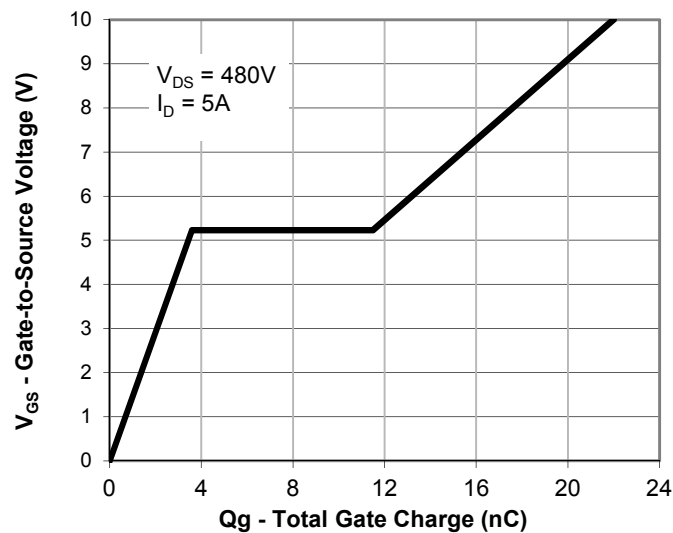

**Drain-to-Source Breakdown Voltage vs. Junction Temperature**

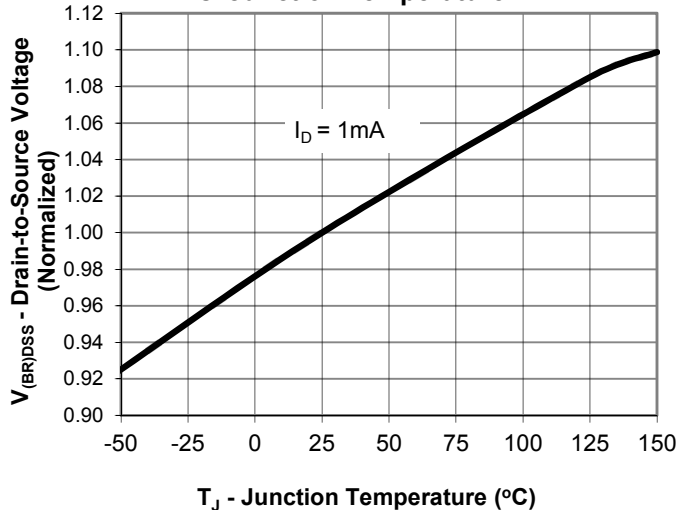

**Capacitance**

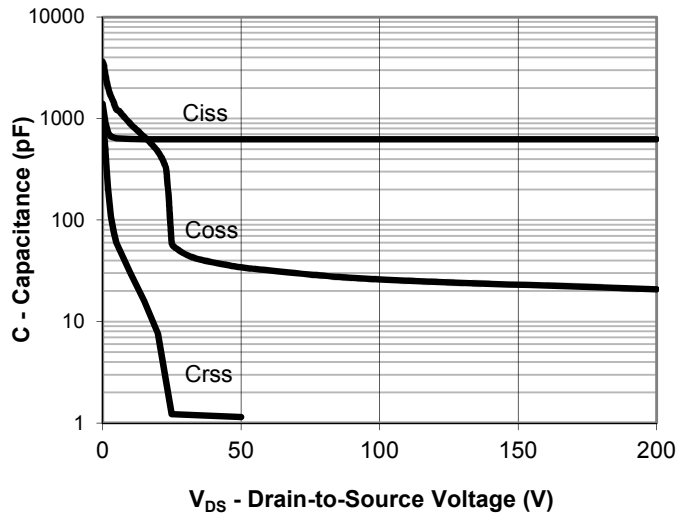

**Source-Drain Diode Forward Voltage**

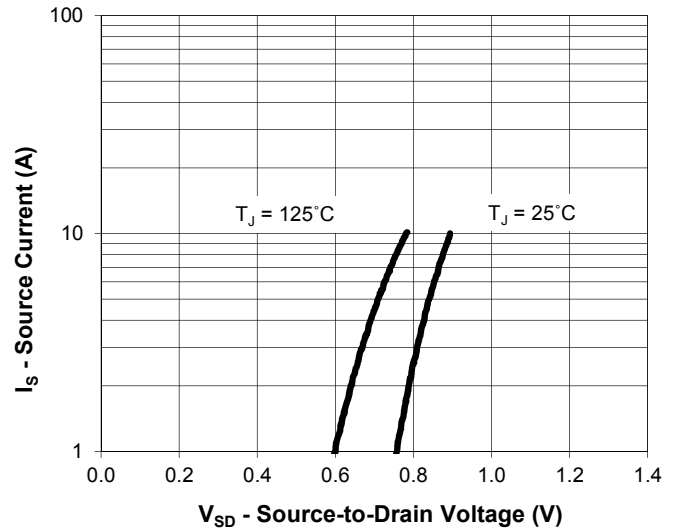

**Maximum Rated Forward Biased Safe Operating Area**

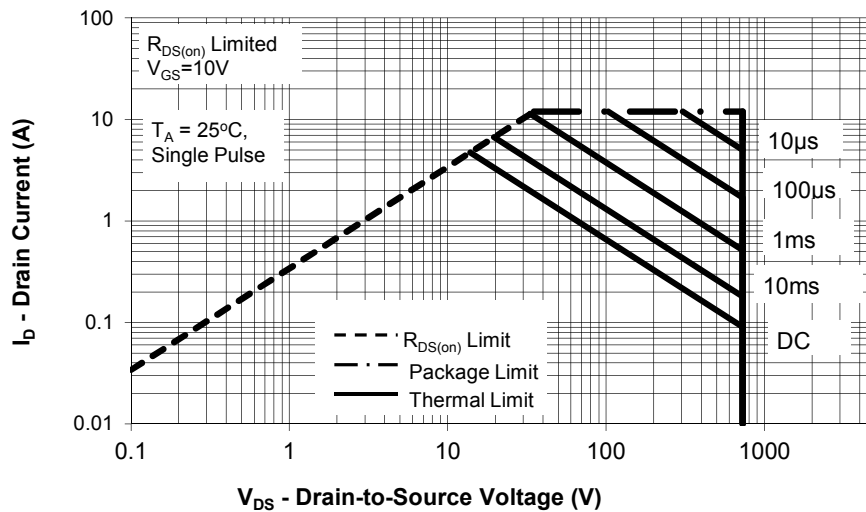

**Transient Thermal Response, Junction-to-Ambient**

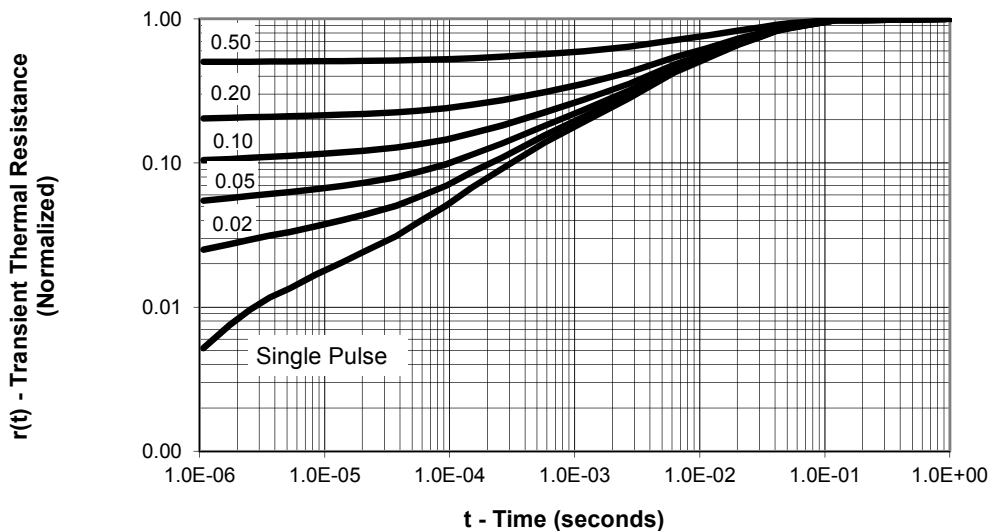

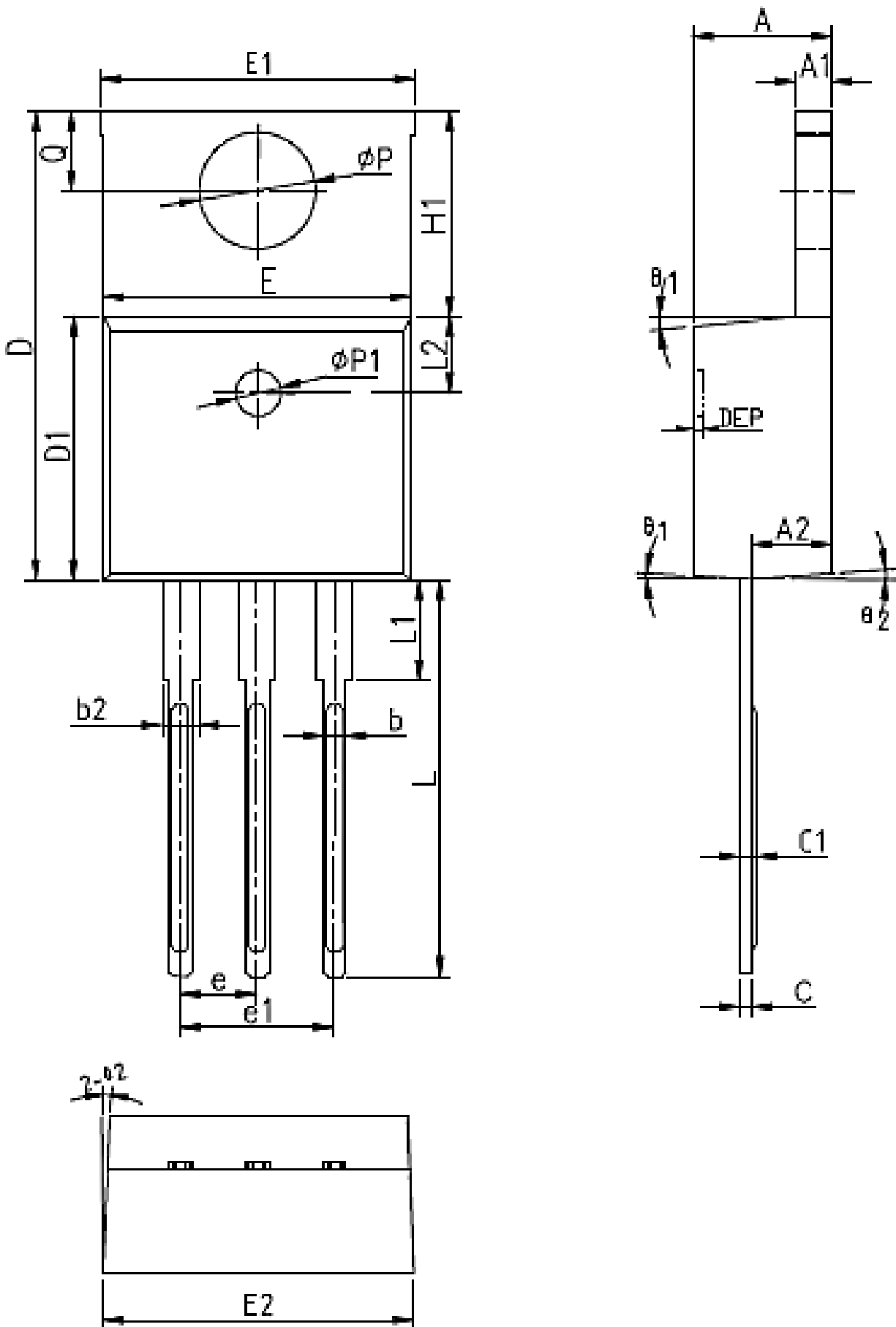

COMMON DIMENSIONS						
SYMBOL	MM			INCH		
	MIN	NOM	MAX	MIN	NOM	MAX
A	3.556	4.191	4.826	0.140	0.165	0.190
A1	0.508	1.397	1.40	0.020	0.055	0.055
A2	2.032	2.476	2.921	0.080	0.097	0.115
b	0.356	0.633	0.91	0.014	0.025	0.036
b2	1.05	1.21	1.37	0.041	0.048	0.054
c	0.31	0.46	0.61	0.012	0.018	0.024
c1	0.33	0.465	0.60	0.013	0.018	0.024
D	14.224	15.367	16.51	0.560	0.605	0.650
D1	8.382	8.816	9.25	0.330	0.347	0.364
E	9.652	10.16	10.668	0.380	0.400	0.420
E1	10.10	10.25	10.35	0.398	0.404	0.407
E2	10.00	10.10	10.20	0.394	0.398	0.402
e	2.54 BSC			0.100 BSC		
e1	5.08 BSC			0.200 BSC		
H1	5.842	6.35	6.858	0.230	0.250	0.270
L	12.70	13.716	14.732	0.500	0.540	0.580
L1	3.56	5.145	6.35	0.140	0.203	0.250
L2	2.50 REF			0.098 REF		
ΦP	3.55	3.72	3.89	0.140	0.146	0.153
Q	2.54	2.997	3.048	0.102	0.108	0.114
θ1	5°	7°	9°	5°	7°	9°
θ2	1°	3°	5°	1°	3°	5°
ΦP1	1.40	1.75	2.10	0.055	0.069	0.083
DEP	0.05	0.10	0.20	0.002	0.004	0.008

## ICEMOS SUPERJUNCTION PATENT PORTFOLIO

### ICEMOS GRANTED PATENTS

US7,429,772

US7,439,178

US7,446,018

US7,579,607

US7,723,172

US7,795,045

US7,846,821

US7,944,018

US8,012,806

US8,030,133

### 3D SEMI PATENTS LICENSED TO ICEMOS

US7,041,560B2

US7,023,069B2

US7,364,994

US7,227,197B2

US7,304,944B2

US7,052,982B2

US7,339,252

US7,410,891

US7,439,583

US7,227,197B2

US6,635,906

US6,936,867

US7,015,104

US9,109,110

US7,271,067

US7,354,818

US7,052,982,

US7,199,006B2

Note: additional patents in China, Korea, Japan, Taiwan, Europe have also been granted to IceMOS and 3D Semi for Superjunction MOSFETs with 70 additional Patent applications in process in the USA and the above listed countries.



## Marking Information

**YY** = Last two digits of the year

**WW** = Work week calendar on Icemos subcon assembly & test house

**\*** = Initial for Icemos subcon assembly and test house

**XXXXXX** = Lot ID

**ICE5N65** = ICE is Icemos logo and 5N65 is a designated device part number

