

### ICE25S65 N-Channel Enhancement Mode MOSFET



HALOGEN  
FREE

Product Summary			
$I_D$	$T_A=25^\circ\text{C}$	25A	Max
$BV_{DSS}$	$I_D=250\mu\text{A}$	650V	Min
$r_{DS(on)}$	$V_{GS}=10\text{V}$	0.12 $\Omega$	Typ
$Q_g$	$V_{DS}=480\text{V}$	34nC	Typ

#### Features

- Low  $r_{DS(on)}$
- Ultra Low Gate Charge
- High  $dv/dt$  capability
- High Unclamped Inductive Switching (UIS) capability
- High peak current capability
- Optimized design for hard switching SMPS topologies

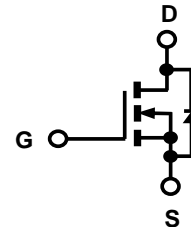

T0220

Standard Metal Heatsink

1=Gate, 2=Drain, 3=Source.

ICEMOS AND ITS SISTER COMPANY 3D SEMI OWN THE FUNDAMENTAL PATENTS FOR SUPERJUNCTION MOSFETS. THE MAJORITY OF THESE PATENTS HAVE 17 to 20 YEARS OF REMAINING LIFE. THIS PORTFOLIO HAS GRANTED PATENTS ISSUED IN USA, CHINA, KOREA, JAPAN, TAIWAN & EUROPE.

#### Maximum ratings at $T_j=25^\circ\text{C}$ , unless otherwise specified

Parameter	Symbol	Conditions	Value	Unit
Continuous drain current	$I_D$	$T_c=25^\circ\text{C}$ $T_c=100^\circ\text{C}$	25 16.2	A
Pulsed drain current	$I_{D, pulse}$	$T_c=25^\circ\text{C}$	80	A
Avalanche energy, single pulse	$E_{AS}$	$I_D=8\text{A}$	320	mJ
Avalanche current, repetitive	$I_{AR}$	limited by $T_j\text{max}$	8	A
MOSFET $dv/dt$ ruggedness	$dv/dt$	$V_{DS}=480\text{V}$ , $I_D=25\text{A}$ , $T_j=125^\circ\text{C}$	50.0	V/ns
Gate source voltage	$V_{GS}$	Static	$\pm 20$	V
		AC ( $f>1\text{Hz}$ )	$\pm 30$	
Power dissipation	$P_{tot}$	$T_c=25^\circ\text{C}$	245	W
Operating and storage temperature	$T_j, T_{stg}$		-55 to +150	$^\circ\text{C}$
Mounting torque <sup>a</sup>		M 3 & 3.5 screws	60	Ncm

<sup>a</sup> When mounted on 1inch square 2oz copper clad FR-4

Parameter	Symbol	Conditions	Values			Unit
			Min	Typ	Max	

### Thermal characteristics

Thermal resistance, junction-case <sup>a</sup>	$R_{thJC}$		-	-	0.51	°C/W
Thermal resistance, junction-ambient <sup>a</sup>	$R_{thJA}$	leaded	-	-	62	
Soldering temperature, wave soldering only allowed at leads	$T_{sold}$	1.6mm (0.063in.) from case for 10 s	-	-	260	°C

### Electrical characteristics at $T_j=25^{\circ}\text{C}$ , unless otherwise specified

#### Static characteristics

Drain-source breakdown voltage	$V_{(BR)DSS}$	$V_{GS}=0\text{ V}, I_D=250\mu\text{A}$	650	700	-	V
Gate threshold voltage	$V_{GS(th)}$	$V_{DS}=V_{GS}, I_D=250\mu\text{A}$	2.5	3	3.5	
Zero gate voltage drain current	$I_{DSS}$	$V_{DS}=650\text{V}, V_{GS}=0\text{V}, T_j=25^{\circ}\text{C}$	-	0.8	1	$\mu\text{A}$
		$V_{DS}=650\text{V}, V_{GS}=0\text{V}, T_j=150^{\circ}\text{C}$	-	100	-	
Gate source leakage current	$I_{GSS}$	$V_{GS}=\pm 20\text{ V}, V_{DS}=0\text{V}$	-	-	100	nA
Drain-source on-state resistance	$r_{DS(on)}$	$V_{GS}=10\text{V}, I_D=12.5\text{A}, T_j=25^{\circ}\text{C}$	-	0.120	0.133	$\Omega$
		$V_{GS}=10\text{V}, I_D=12.5\text{A}, T_j=150^{\circ}\text{C}$	-	0.34	-	
Gate resistance	$R_G$	$f=1\text{ MHz}, \text{open drain}$	-	3	-	$\Omega$

#### Dynamic characteristics

Input capacitance	$C_{iss}$	$V_{GS}=0\text{ V}, V_{DS}=25\text{V}, f=1\text{ MHz}$	-	1650	-	pF
Output capacitance	$C_{oss}$		-	234	-	
Reverse transfer capacitance	$C_{riss}$		-	3	-	
Output capacitance	$C_{oss}$	$V_{GS}=0\text{ V}, V_{DS}=100\text{ V}, f=1\text{ MHz}$	-	73	-	
Transconductance	$g_{fs}$	$V_{DS}>2 \cdot I_D \cdot R_{DS}, I_D=12.5\text{A}$	-	23	-	S
Turn-on delay time	$t_{d(on)}$	$V_{DS}=380\text{V}, V_{GS}=10\text{V}, I_D=25\text{A}, R_G=4\Omega \text{ (External)}$	-	27	-	ns
Rise time	$t_r$		-	119	-	
Turn-off delay time	$t_{d(off)}$		-	77	-	
Fall time	$t_f$		-	123	-	

Parameter	Symbol	Conditions	Values			Unit
			Min	Typ	Max	

### Gate charge characteristics

Gate to source charge	$Q_{gs}$	$V_{DS}=480\text{ V}, I_D=25\text{ A},$ $V_{GS}=10\text{ V}$	-	7	-	nC
Gate to drain charge	$Q_{gd}$		-	7	-	
Gate charge total	$Q_g$		-	34	-	
Gate plateau voltage	$V_{plateau}$		-	5.0	-	V

### Reverse Diode

Continuous forward current	$I_S$	$V_{GS}=0\text{ V}$	-	-	25	A
Diode forward voltage	$V_{SD}$	$V_{GS}=0\text{ V}, I_S=I_F$	-	1.0	1.2	V
Reverse recovery time	$t_{rr}$	$V_{RR}=50\text{ V}, I_S=I_F,$ $d_{iF}/d_t=100\text{ A}/\mu\text{S}$	-	326	-	ns
Reverse recovery charge	$Q_{rr}$		-	5.6	-	$\mu\text{C}$
Peak reverse recovery current	$I_{rm}$		-	38	-	A

**Output Characteristics**

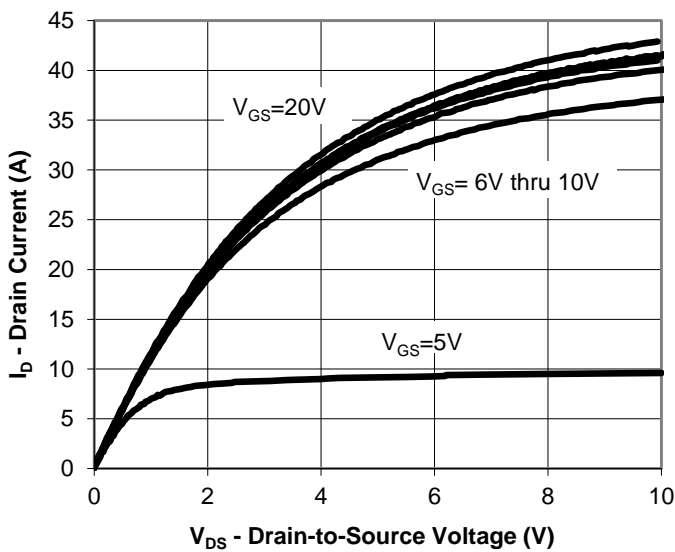

**Transfer Characteristics**

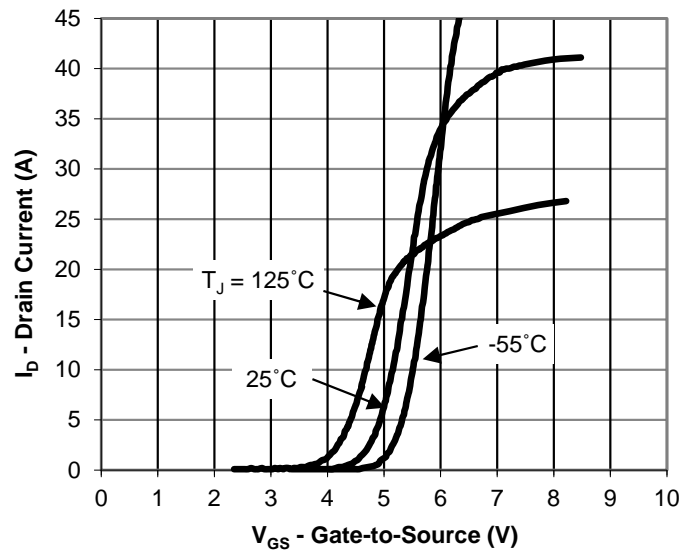

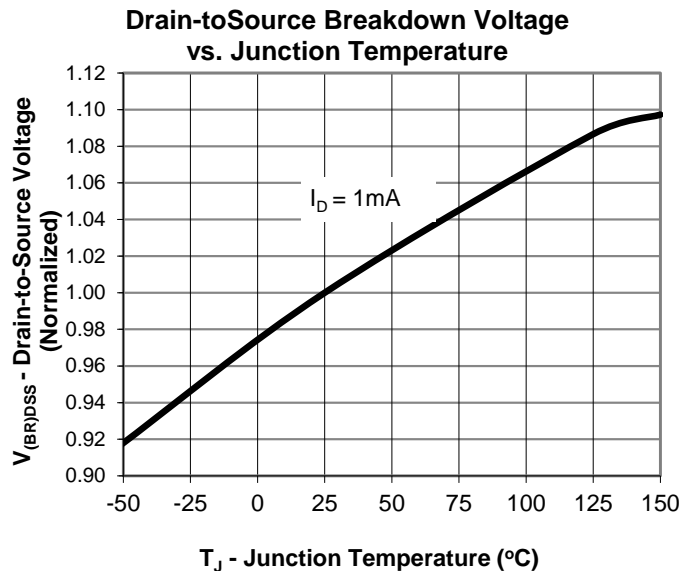
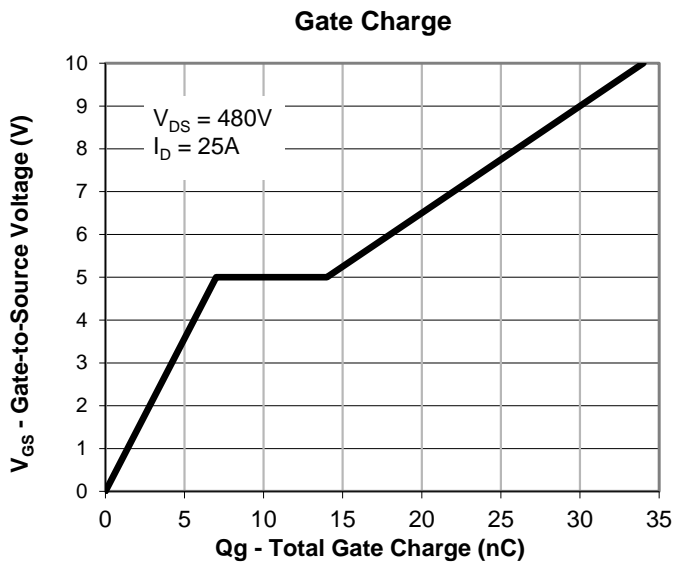
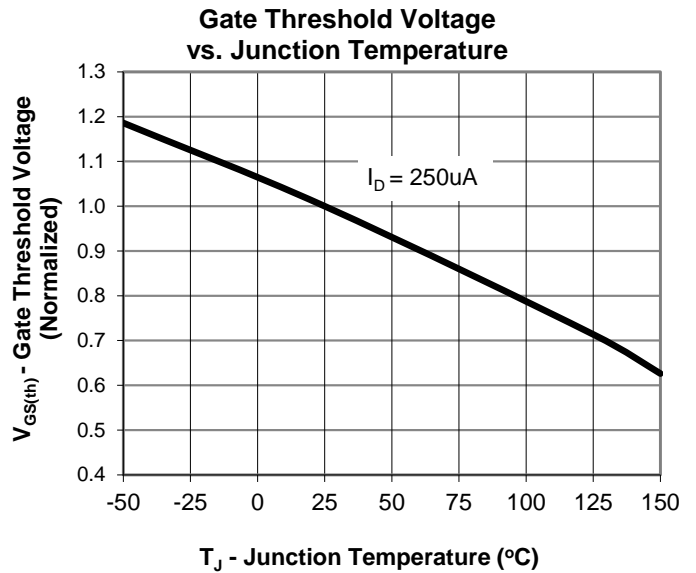
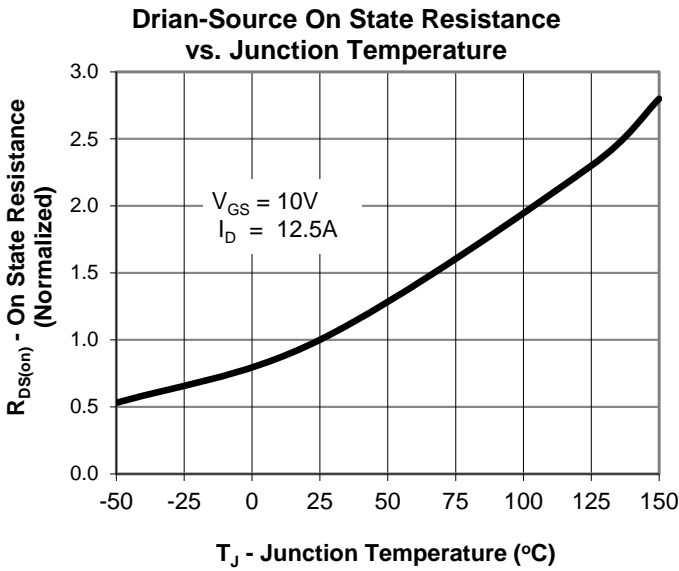
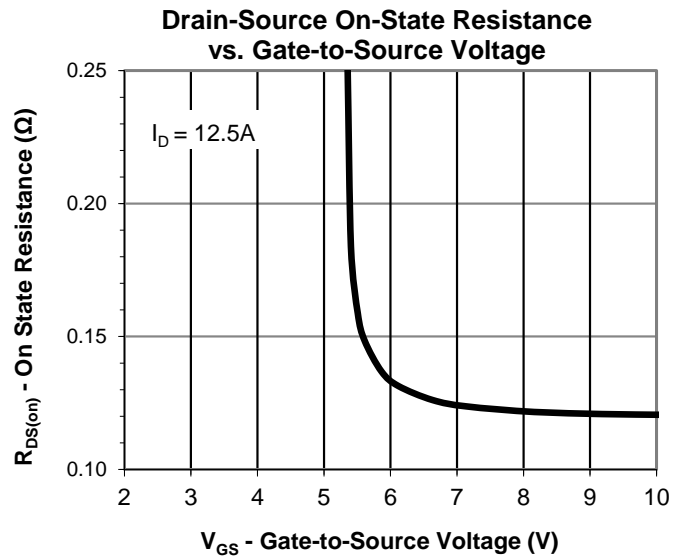
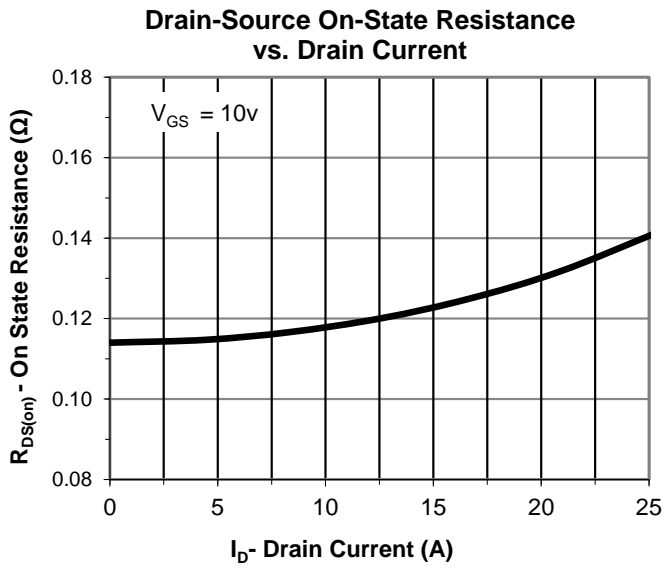

### Capacitance

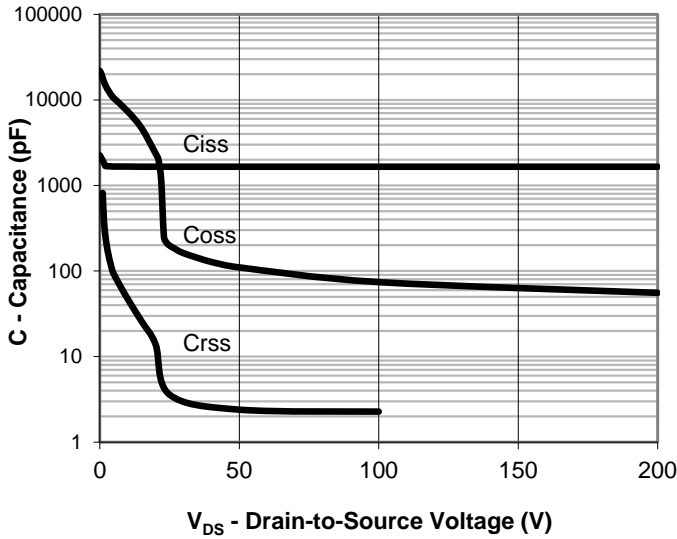

### Source-Drain Diode Forward Voltage

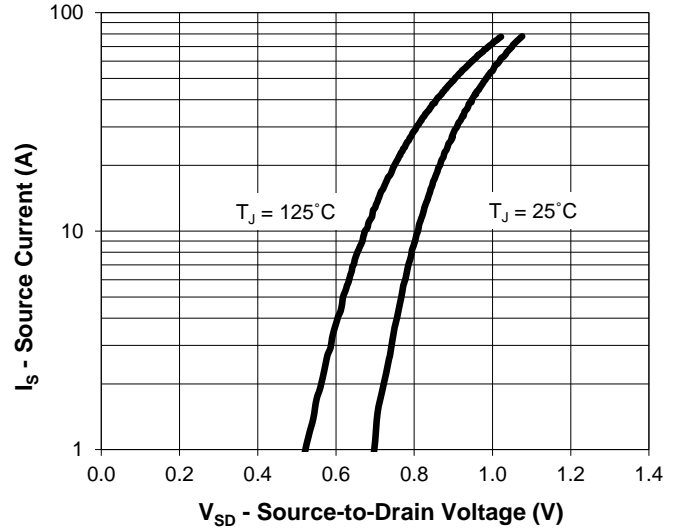

### Maximum Rated Forward Biased Safe Operating Area

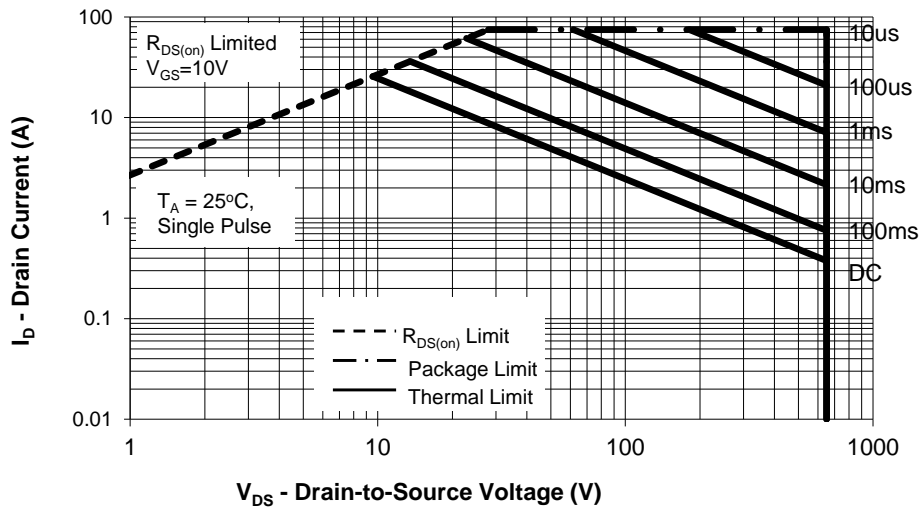

### Transient Thermal Response, Junction-to-Ambient

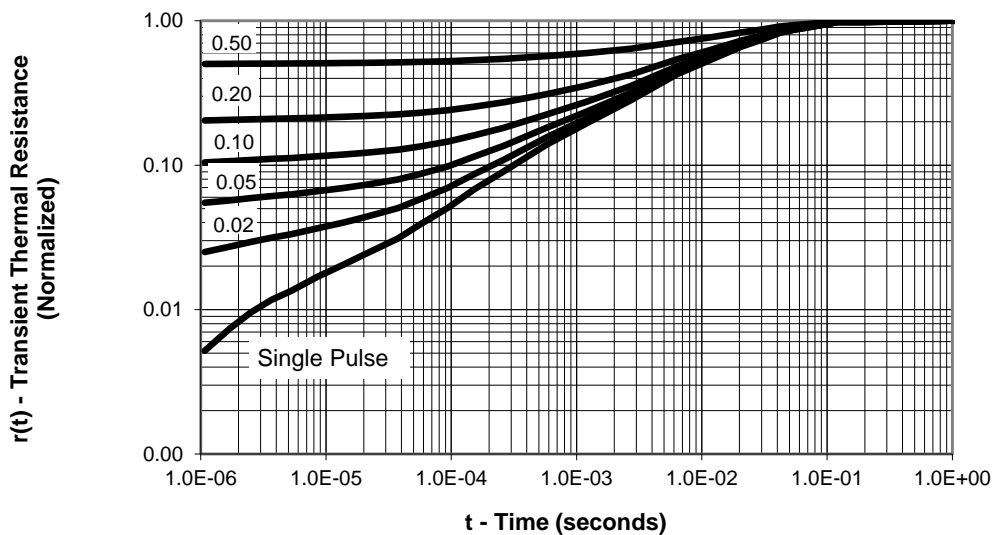

## Package Outline: TO-220

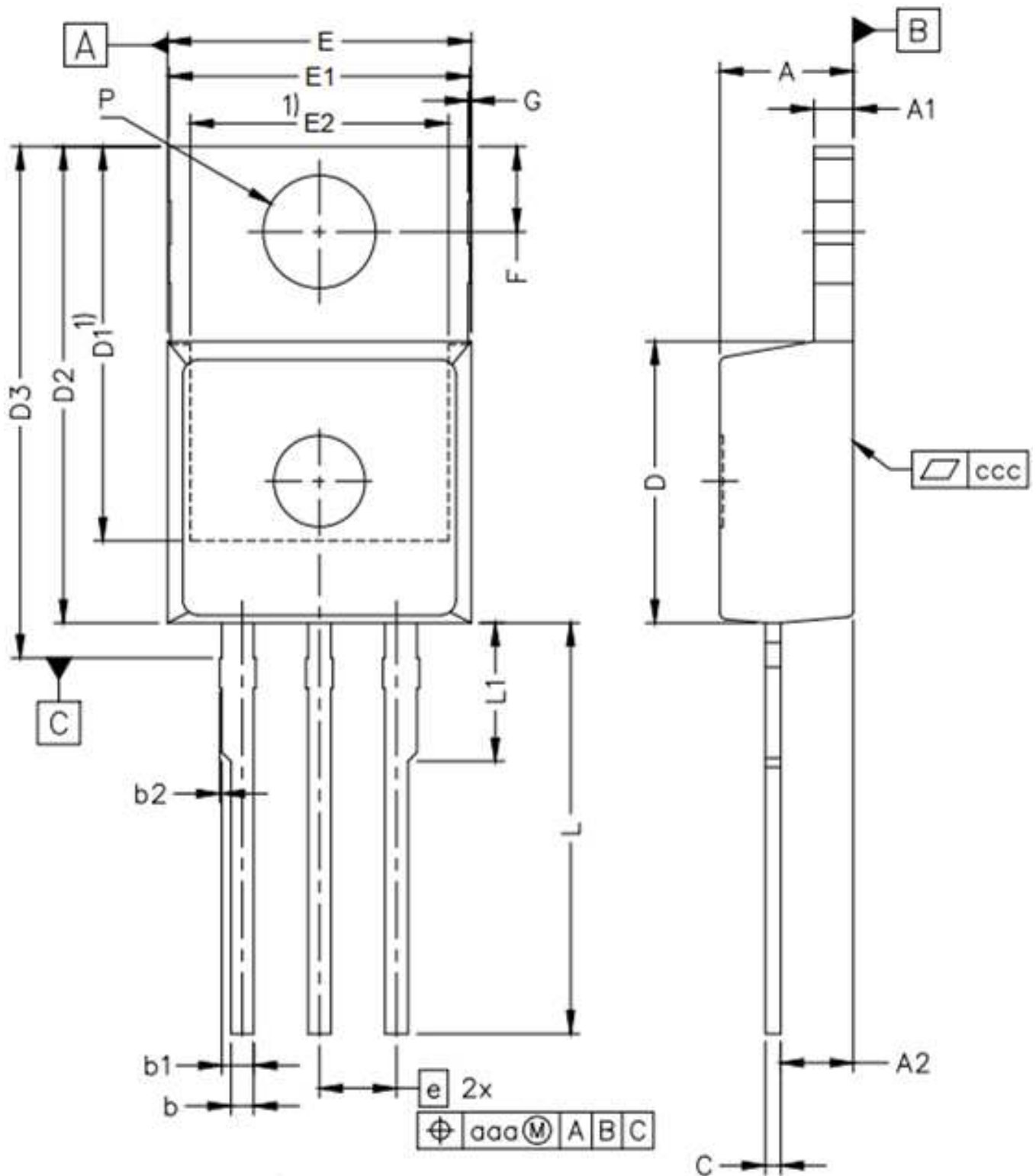

## Package Outline: TO-220

**NOTE :**

- 1). TYPICAL METAL SURFACE Min. X=7.25 / Y=12.3  
ALL METAL SURFACES: TIN PLATED, EXCEPT AREA OF CUT
2. DIMENSIONING & TOLERANCEING CONFIRM TO  
ASME Y14.5M-1994.
3. ALL DIMENSIONS ARE IN MILLIMETERS.  
ANGLES ARE IN DEGREES.
4. RADIUS ON TERMINAL IS OPTIONAL.
5. GENERAL TOLERANCES - LINEAR  $\pm 0.05$
6. PLASTIC BODY ANGLES: 5° UNLESS OTHERWISE SPECIFIED.
7. PLASTIC BODY RADIUS: MAX. 0.25 UNLESS OTHERWISE SPECIFIED.
8. PLASTIC BODY FINISHIN: MATT FINISHING Ra=1.7~2 MICRONS
9. MISMATCH MAX.=0.05 (CAVITY TO HOLE AXIS)}
10. ASTERISKED QUOTES ARE SUBJECTED TO THE SPC CALCULATION  
(Cp,K,Cpk).

SYMBOL	MIN	MAX
A	4.20	4.60
A1	1.20	1.40
A2	2.20	2.60
b	0.65	0.85
b1	0.95	1.15
b2	-	0.15
C	0.40	0.60
D	9.05	9.45
D1	12.95 REF.	
D2	15.35	15.95
D3	16.50	17.10
E	9.80	10.20
E1	9.70	10.10
E2	8.50 REF.	
e	2.54 BSC	
F	2.60	3.00
G	0.10 REF.	
L	13.00	14.00
L1	4.35	4.75
P	3.55	3.85
aaa	0.25	
ccc	0.05	

## ICEMOS SUPERJUNCTION PATENT PORTFOLIO

### ICEMOS GRANTED PATENTS

US7,429,772

US7,439,178

US7,446,018

US7,579,607

US7,723,172

US7,795,045

US7,846,821

US7,944,018

US8,012,806

US8,030,133

### 3D SEMI PATENTS LICENSED TO ICEMOS

US7,041,560B2

US7,023,069B2

US7,364,994

US7,227,197B2

US7,304,944B2

US7,052,982B2

US7,339,252

US7,410,891

US7,439,583

US7,227,197B2

US6,635,906

US6,936,867

US7,015,104

US9,109,110

US7,271,067

US7,354,818

US7,052,982,

US7,199,006B2

Note: additional patents in China, Korea, Japan, Taiwan, Europe have also been granted to IceMOS and 3D Semi for Superjunction MOSFETs with 70 additional Patent applications in process in the USA and the above listed countries.



### Marking Information

**YY** = Last two digits of the year

**WW** = Work week calendar on Icemos subcon assembly & test house

**\*** = Site ID

**XXXXXX** = Lot ID

**ICE25S65** = ICE is IceMOS logo and 25S65 is a designated device part number

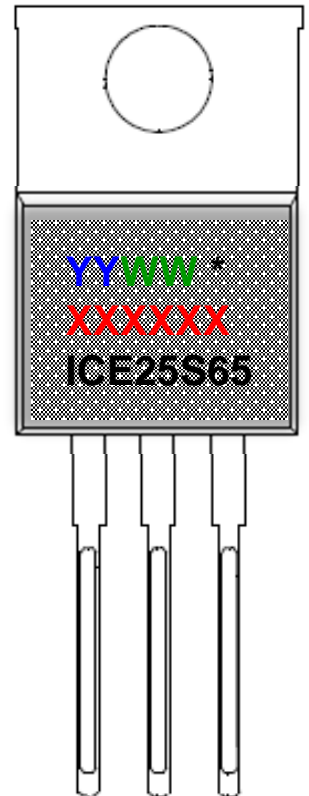

### Disclaimer

Information contained in this data sheet shall in no event be regarded as a guarantee of conditions or characteristics. All product, data sheet are subject to change without notice to improve reliability. ICEMOS technology will not be responsible for damages of any nature resulting from the use or reliance upon the information contained in this data sheet.